



PREGLED SUDJELOVANJA

Prvenstvo ZG žup za kadete i seniore GR

KAD GR

R.br.	EKIPA	MJESTO	42 kg	46 kg	50 kg	54 kg	58 kg	63 kg	69 kg	76 kg	85 kg	100 kg	Ukupno
1	BISTRA	BISTRA					2			1			3
2	LIKA	ZAGREB			1	1		1					3
3	LOKOMOTIVA	ZAGREB						1					1
4	METALAC	ZAGREB						1	2		1	1	5
5	PIK VRBOVEC	VRBOVEC				1				1	1	1	4
6	SESVETE	ZAGREB	1						1			1	3
7	SESVETSKI KRALJEVEC	SESV. KRALJEVEC	1	1	1			4	1		3	2	13
8	TREŠNJEVKA	ZAGREB							1				1
9	ZAGREB	ZAGREB						1	2	1	3		7
UKUPNO NATJECATELJA			2	1	2	2	2	8	7	3	8	5	40



TABLICA ELIMINACIJE

Prvenstvo ZG žup za kadete i seniore GR

KAD GR 42 kg

R.br.	Hrvač	Ekipa	1	2	PP	PL.
1	ĐAPIĆ Matej	SESVETE		4	4	1.
2	ŽEGMAN Dominik	SESVETSKI KRALJ	0		0	2.

N1						
1	4 0	ĐAPIĆ Matej	SES	P1 0	P2 0	P3 0
2	0 0	ŽEGMAN Dominik	SEK	P1 0	P2 0	P3 0

KONAČNI POREDAK

Plasman	Hrvač	Ekipa
1	ĐAPIĆ Matej	SES
2	ŽEGMAN Dominik	SEKR



TABLICA ELIMINACIJE

Prvenstvo ZG žup za kadete i seniore GR

KAD GR 46 kg

R.br.	Hrvač	Ekipa	1	PP	PL.
1	IVIĆ Juraj	SESVETSKI KRALJ		0	1.

KONAČNI POREDAK

Plasman	Hrvač	Ekipa
1	IVIĆ Juraj	SEKR



TABLICA ELIMINACIJE

Prvenstvo ZG žup za kadete i seniore GR

KAD GR 50 kg

R.br.	Hrvač	Ekipa	1	2	PP	PL.
1	ĐURIĆ Tomislav	LIKA		4	4	1.
2	CAFUK Jurica	SESVETSKI KRALJ	0		0	2.

N1						
1	4 0	ĐURIĆ Tomislav	LIK	P1 0	P2 0	P3 0
2	0 0	CAFUK Jurica	SEK	P1 0	P2 0	P3 0

KONAČNI POREDAK

Plasman	Hrvač	Ekipa
1	ĐURIĆ Tomislav	LIKA
2	CAFUK Jurica	SEKR



TABLICA ELIMINACIJE

Prvenstvo ZG žup za kadete i seniore GR

KAD GR 54 kg

R.br.	Hrvač	Ekipa	1	2	PP	PL.
1	GREGORAN Karlo	PIK VRBOVEC		0	0	2.
2	ČIBARIĆ Antonio	LIKA	4		4	1.

N1						
1	0 0	GREGORAN Karlo	PIK	P1 0	P2 0	P3 0
2	4 0	ČIBARIĆ Antonio	LIK	P1 0	P2 0	P3 0

KONAČNI POREDAK

Plasman	Hrvač	Ekipa
1	ČIBARIĆ Antonio	LIKA
2	GREGORAN Karlo	PIKV



TABLICA ELIMINACIJE

Prvenstvo ZG žup za kadete i seniore GR

KAD GR 58 kg

R.br.	Hrvač	Ekipa	1	2	PP	PL.
1	PRIHISTAL Tin	BISTRA		0	0	2.
2	PRIHISTAL Luka	BISTRA	4		4	1.

N1						
1	0	PRIHISTAL Tin	BIS	P1	P2	P3
	0			0	0	
2	4	PRIHISTAL Luka	BIS	P1	P2	P3
	0			0	0	

KONAČNI POREDAK

Plasman	Hrvač	Ekipa
1	PRIHISTAL Luka	BIS
2	PRIHISTAL Tin	BIS



TABLICA ELIMINACIJE

Prvenstvo ZG žup za kadete i seniore GR

KAD GR 63 kg

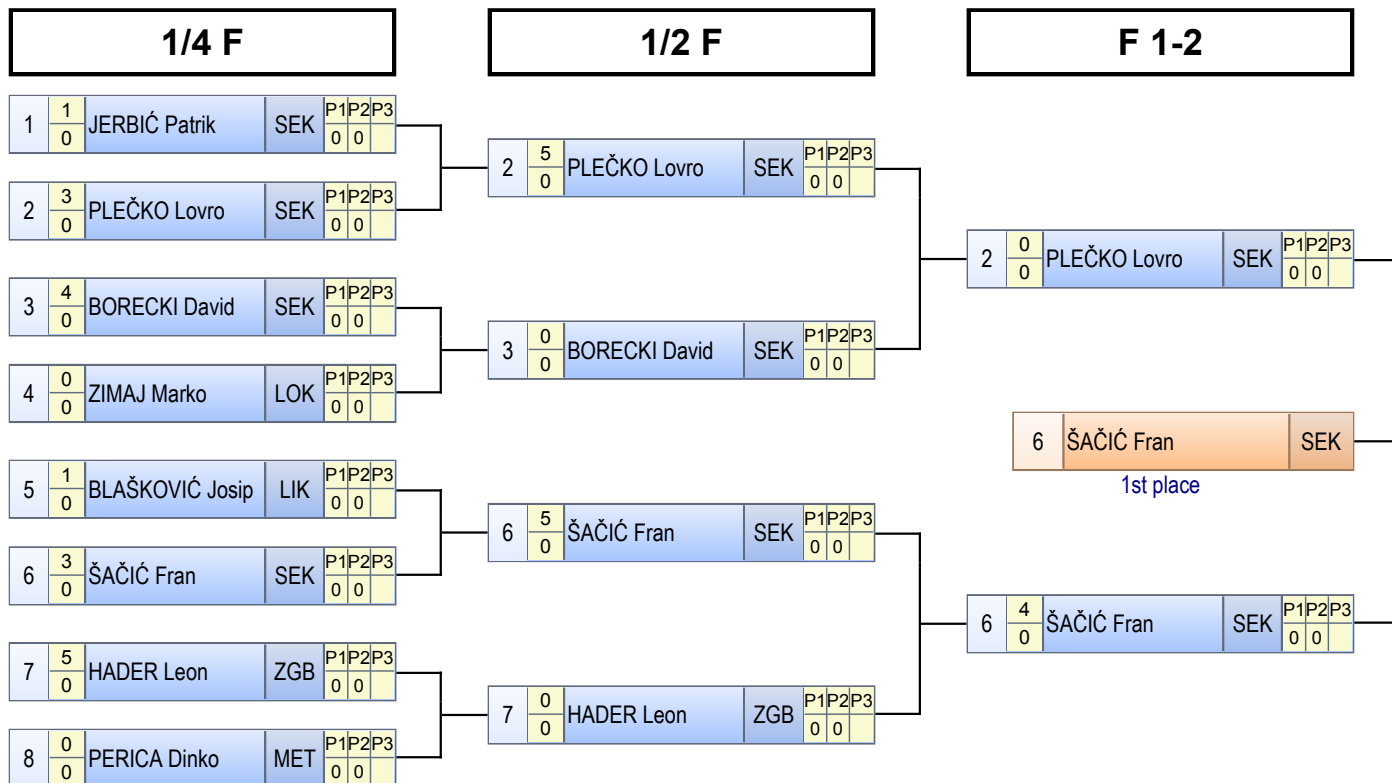

KONAČNI POREDAK

Repechage A

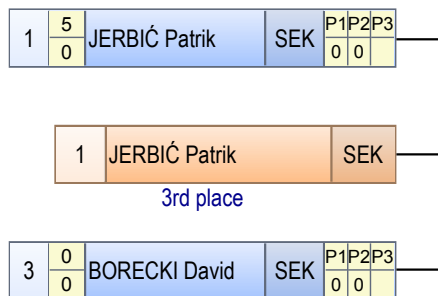

Repechage B

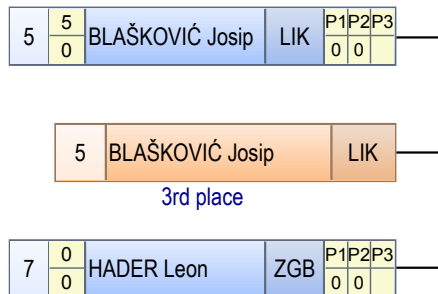

Plasman	Hrvač	Ekipa
1	ŠAČIĆ Fran	SEKR
2	PLEČKO Lovro	SEKR
3	JERBIĆ Patrik	SEKR
3	BLAŠKOVIĆ Josip	LIKA
5	BORECKI David	SEKR
5	HADER Leon	ZGB
7	ZIMAJ Marko	LOK
7	PERICA Dinko	MET



TABLICA ELIMINACIJE

Prvenstvo ZG žup za kadete i seniore GR

KAD GR 69 kg

Q

2	0/0	SOBOTA Teo	TRE	P1P2P3 0 0
3	5/0	IVANČIĆ Marko	SES	P1P2P3 0 0
4	0/0	STAJČIĆ Danijel	MET	P1P2P3 0 0
5	5/0	MANDIĆ Matej	MET	P1P2P3 0 0
6	3/0	HEDŽIĆ Mirza	ZGB	P1P2P3 0 0
7	1/0	ĆOSIĆ Tomislav	ZGB	P1P2P3 0 0

1/2 F

1	0/0	HABEK Lovro	SEK	P1P2P3 0 0
3	4/0	IVANČIĆ Marko	SES	P1P2P3 0 0
5	4/0	MANDIĆ Matej	MET	P1P2P3 0 0
6	0/0	HEDŽIĆ Mirza	ZGB	P1P2P3 0 0

F 1-2

3	3/0	IVANČIĆ Marko	SES	P1P2P3 0 0
3		IVANČIĆ Marko	SES	
1st place				
5	1/0	MANDIĆ Matej	MET	P1P2P3 0 0

Repechage A

2	0/0	SOBOTA Teo	TRE	P1P2P3 0 0
1		HABEK Lovro	SEK	
3rd place				
1	4/0	HABEK Lovro	SEK	P1P2P3 0 0

Repechage B

4	0/0	STAJČIĆ Danijel	MET	P1P2P3 0 0
6		HEDŽIĆ Mirza	ZGB	
3rd place				
6	5/0	HEDŽIĆ Mirza	ZGB	P1P2P3 0 0

KONAČNI POREDAK

Plasman	Hrvač	Ekipa
1	IVANČIĆ Marko	SES
2	MANDIĆ Matej	MET
3	HABEK Lovro	SEKR
3	HEDŽIĆ Mirza	ZGB
5	SOBOTA Teo	TREŠ
5	STAJČIĆ Danijel	MET
7	ĆOSIĆ Tomislav	ZGB



TABLICA ELIMINACIJE

Prvenstvo ZG žup za kadete i seniore GR

KAD GR 76 kg

R.br.	Hrvač	Ekipa	1	2	3	PP	PL.
1	ŠTAVLIĆ Tomi	ZAGREB		1	0	1	3.
2	BREZOVIĆ Ivan	BISTRA	3		1	4	2.
3	ŠOPLER Stjepan	PIK VRBOVEC	4	4		8	1.

N1

1	1 0	ŠTAVLIĆ Tomi	ZGB	P1 0	P2 0	P3 0
2	3 0	BREZOVIĆ Ivan	BIS	P1 0	P2 0	P3 0

N2

3	4 0	ŠOPLER Stjepan	PIK	P1 0	P2 0	P3 0
1	0 0	ŠTAVLIĆ Tomi	ZGB	P1 0	P2 0	P3 0

N3

2	1 0	BREZOVIĆ Ivan	BIS	P1 0	P2 0	P3 0
3	4 0	ŠOPLER Stjepan	PIK	P1 0	P2 0	P3 0

KONAČNI POREDAK

Plasman	Hrvač	Ekipa
1	ŠOPLER Stjepan	PIKV
2	BREZOVIĆ Ivan	BIS
3	ŠTAVLIĆ Tomi	ZGB



TABLICA ELIMINACIJE

Prvenstvo ZG žup za kadete i seniore GR

KAD GR 85 kg

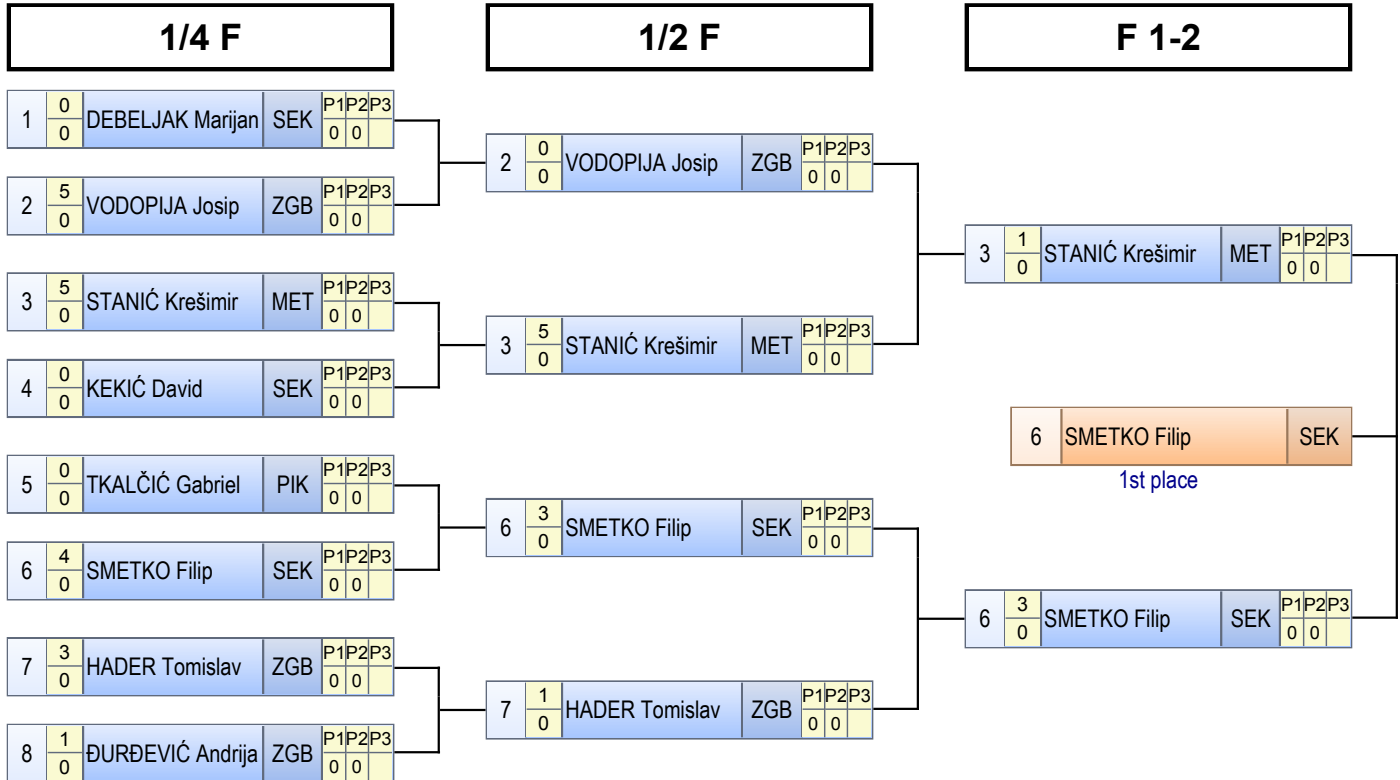

KONAČNI POREDAK

Plasman	Hrvač	Ekipa
1	SMETKO Filip	SEKR
2	STANIĆ Krešimir	MET
3	KEKIĆ David	SEKR
3	HADER Tomislav	ZGB
5	VODOPIJA Josip	ZGB
5	TKALČIĆ Gabriel	PIKV
7	ĐURĐEVIĆ Andrija	ZGB
8	DEBELJAK Marijan	SEKR

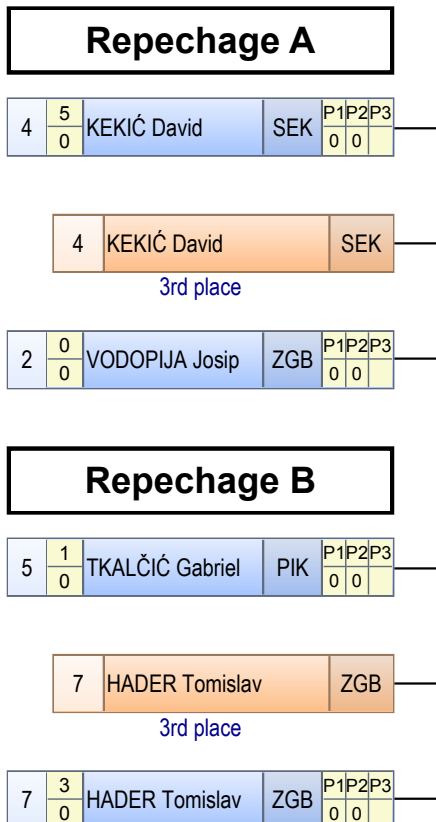



TABLICA ELIMINACIJE

Prvenstvo ZG žup za kadete i seniore GR

KAD GR 100 kg

R.br.	Hrvač	Ekipa	1	2	3	4	5	PP	PL.
1	IVANJKO David	SESVETE		4	3	3	4	14	1.
2	MARKIĆ Marko	SESVETSKI KRALJ	0		0	4	4	8	3.
3	ŽUNIĆ Tin	METALAC	1	4		4	4	13	2.
4	VEŠLIGAJ Tomislav	PIK VRBOVEC	1	1	0		5	7	4.
5	KRNJAK David	SESVETSKI KRALJ	0	0	0	0		0	5.

N1

1	4 0	IVANJKO David	SES	P1P2P3 0 0
2	0 0	MARKIĆ Marko	SEK	P1P2P3 0 0

3	4 0	ŽUNIĆ Tin	MET	P1P2P3 0 0
4	0 0	VEŠLIGAJ Tomislav	PIK	P1P2P3 0 0

N2

5	0 0	KRNJAK David	SEK	P1P2P3 0 0
1	4 0	IVANJKO David	SES	P1P2P3 0 0

2	0 0	MARKIĆ Marko	SEK	P1P2P3 0 0
3	4 0	ŽUNIĆ Tin	MET	P1P2P3 0 0

N3

4	1 0	VEŠLIGAJ Tomislav	PIK	P1P2P3 0 0
1	3 0	IVANJKO David	SES	P1P2P3 0 0

5	0 0	KRNJAK David	SEK	P1P2P3 0 0
2	4 0	MARKIĆ Marko	SEK	P1P2P3 0 0

N4

3	1 0	ŽUNIĆ Tin	MET	P1P2P3 0 0
1	3 0	IVANJKO David	SES	P1P2P3 0 0

4	5 0	VEŠLIGAJ Tomislav	PIK	P1P2P3 0 0
5	0 0	KRNJAK David	SEK	P1P2P3 0 0

N5

2	4 0	MARKIĆ Marko	SEK	P1P2P3 0 0
4	1 0	VEŠLIGAJ Tomislav	PIK	P1P2P3 0 0

3	4 0	ŽUNIĆ Tin	MET	P1P2P3 0 0
5	0 0	KRNJAK David	SEK	P1P2P3 0 0

KONAČNI POREDAK

Plasman	Hrvač	Ekipa
1	IVANJKO David	SES
2	ŽUNIĆ Tin	MET
3	MARKIĆ Marko	SEKR
4	VEŠLIGAJ Tomislav	PIKV
5	KRNJAK David	SEKR



POJEDINAČNI POREDAK PO KATEGORIJAMA

Prvenstvo ZG žup za kadete i seniore GR

KAD GR

42 kg			
1	ĐAPIĆ Matej	SESVETE	7.0
2	ŽEGMAN Dominik	SESVETSKI KRALJEVEC	5.0
			12.0
46 kg			
1	IVIĆ Juraj	SESVETSKI KRALJEVEC	7.0
			7.0
50 kg			
1	ĐURIĆ Tomislav	LIKA	7.0
2	CAFUK Jurica	SESVETSKI KRALJEVEC	5.0
			12.0
54 kg			
1	ČIBARIĆ Antonio	LIKA	7.0
2	GREGORAN Karlo	PIK VRBOVEC	5.0
			12.0
58 kg			
1	PRIHISTAL Luka	BISTRA	7.0
2	PRIHISTAL Tin	BISTRA	5.0
			12.0
63 kg			
1	ŠAČIĆ Fran	SESVETSKI KRALJEVEC	7.0
2	PLEČKO Lovro	SESVETSKI KRALJEVEC	5.0
3	JERBIĆ Patrik	SESVETSKI KRALJEVEC	3.5
3	BLAŠKOVIĆ Josip	LIKA	3.5
			19.0
69 kg			
1	IVANČIĆ Marko	SESVETE	7.0
2	MANDIĆ Matej	METALAC	5.0
3	HABEK Lovro	SESVETSKI KRALJEVEC	3.5
3	HEDŽIĆ Mirza	ZAGREB	3.5
			19.0
76 kg			
1	ŠOPLER Stjepan	PIK VRBOVEC	7.0
2	BREZOVIĆ Ivan	BISTRA	5.0
3	ŠTAVLIĆ Tomi	ZAGREB	3.5
			15.5
85 kg			
1	SMETKO Filip	SESVETSKI KRALJEVEC	7.0
2	STANIĆ Krešimir	METALAC	5.0
3	KEKIĆ David	SESVETSKI KRALJEVEC	3.5
3	HADER Tomislav	ZAGREB	3.5
			19.0
100 kg			
1	IVANJKO David	SESVETE	7.0
2	ŽUNIĆ Tin	METALAC	5.0
3	MARKIĆ Marko	SESVETSKI KRALJEVEC	3.5
4	VEŠLIGAJ Tomislav	PIK VRBOVEC	3.5
			19.0



EKIPNI PLASMAN

Prvenstvo ZG žup za kadete i seniore GR

KAD GR

R.br.	EKIPA	MJESTO	42 kg	46 kg	50 kg	54 kg	58 kg	63 kg	69 kg	76 kg	85 kg	100 kg	Ukupno
1	SESVETSKI KRALJEVEC	SESV. KRALJEVEC	5.0	7.0	5.0			15.5	3.5		10.5	3.5	50.0
2	SESVETE	ZAGREB	7.0						7.0			7.0	21.0
3	LIKA	ZAGREB			7.0	7.0		3.5					17.5
4	BISTRA	BISTRA					12.0			5.0			17.0
5	PIK VRBOVEC	VRBOVEC				5.0				7.0		3.5	15.5
6	METALAC	ZAGREB							5.0		5.0	5.0	15.0
7	ZAGREB	ZAGREB							3.5	3.5	3.5		10.5
8	TREŠNJEVKA	ZAGREB											0.0
9	LOKOMOTIVA	ZAGREB											0.0
UKUPNO			12	7	12	12	12	19	19	15.5	19	19	146.5



PREGLED SUDJELOVANJA

Prvenstvo ZG žup za kadete i seniore GR

SEN GR

R.br.	EKIPA	MJESTO	59 kg	66 kg	71 kg	75 kg	80 kg	85 kg	98 kg	130 kg	Ukupno
1	HRVATSKI DRAGOVOLJAC	ZAGREB			1						1
2	LIKA	ZAGREB			1	1		1		3	6
3	LOKOMOTIVA	ZAGREB	1	1	2		2			3	9
4	METALAC	ZAGREB			3	1	3		1		8
5	PIK VRBOVEC	VRBOVEC	2			1	2	1			6
6	SESVETE	ZAGREB		2		1	2	1	2	3	11
7	SESVETSKI KRALJEVEC	SESV. KRALJEVEC	1	2	1	2	4	2	3		15
8	TREŠNJEVKA	ZAGREB								1	1
9	ZAGREB	ZAGREB	1	1	1	2	1	1	1		8
UKUPNO NATJECATELJA			5	6	9	8	14	6	7	10	65



TABLICA ELIMINACIJE

Prvenstvo ZG žup za kadete i seniore GR

SEN GR 59 kg

R.br.	Hrvač	Ekipa	1	2	3	4	5	PP	PL.
1	BRALA Tony	ZAGREB		4	4	4	4	16	1.
2	BOLFEK Ivica	PIK VRBOVEC	0		1	4	4	9	3.
3	PETRAK Mario	LOKOMOTIVA	0	3		4	4	11	2.
4	ČIČAK Patric	SESVETSKI KRALJ	0	0	1		4	5	4.
5	MIHALIC Martin	PIK VRBOVEC	0	0	0	0		0	5.

N1

1	$\frac{4}{0}$	BRALA Tony	ZGB	$\frac{P1P2P3}{000}$
2	$\frac{0}{0}$	BOLFEK Ivica	PIK	$\frac{P1P2P3}{000}$
3	$\frac{4}{0}$	PETRAK Mario	LOK	$\frac{P1P2P3}{000}$
4	$\frac{1}{0}$	ČIČAK Patric	SEK	$\frac{P1P2P3}{000}$

N2

5	$\frac{0}{0}$	MIHALIC Martin	PIK	$\frac{P1P2P3}{000}$
1	$\frac{4}{0}$	BRALA Tony	ZGB	$\frac{P1P2P3}{000}$
2	$\frac{1}{0}$	BOLFEK Ivica	PIK	$\frac{P1P2P3}{000}$
3	$\frac{3}{0}$	PETRAK Mario	LOK	$\frac{P1P2P3}{000}$

N3

4	$\frac{0}{0}$	ČIČAK Patric	SEK	$\frac{P1P2P3}{000}$
1	$\frac{4}{0}$	BRALA Tony	ZGB	$\frac{P1P2P3}{000}$
5	$\frac{0}{0}$	MIHALIC Martin	PIK	$\frac{P1P2P3}{000}$
2	$\frac{4}{0}$	BOLFEK Ivica	PIK	$\frac{P1P2P3}{000}$

N4

3	$\frac{0}{0}$	PETRAK Mario	LOK	$\frac{P1P2P3}{000}$
1	$\frac{4}{0}$	BRALA Tony	ZGB	$\frac{P1P2P3}{000}$
4	$\frac{4}{0}$	ČIČAK Patric	SEK	$\frac{P1P2P3}{000}$
5	$\frac{0}{0}$	MIHALIC Martin	PIK	$\frac{P1P2P3}{000}$

N5

2	$\frac{4}{0}$	BOLFEK Ivica	PIK	$\frac{P1P2P3}{000}$
4	$\frac{0}{0}$	ČIČAK Patric	SEK	$\frac{P1P2P3}{000}$
3	$\frac{4}{0}$	PETRAK Mario	LOK	$\frac{P1P2P3}{000}$
5	$\frac{0}{0}$	MIHALIC Martin	PIK	$\frac{P1P2P3}{000}$

KONAČNI POREDAK

Plasman	Hrvač	Ekipa
1	BRALA Tony	ZGB
2	PETRAK Mario	LOK
3	BOLFEK Ivica	PIKV
4	ČIČAK Patric	SEKR
5	MIHALIC Martin	PIKV



TABLICA ELIMINACIJE

Prvenstvo ZG žup za kadete i seniore GR

SEN GR 66 kg

Q

1/2 F

F 1-2

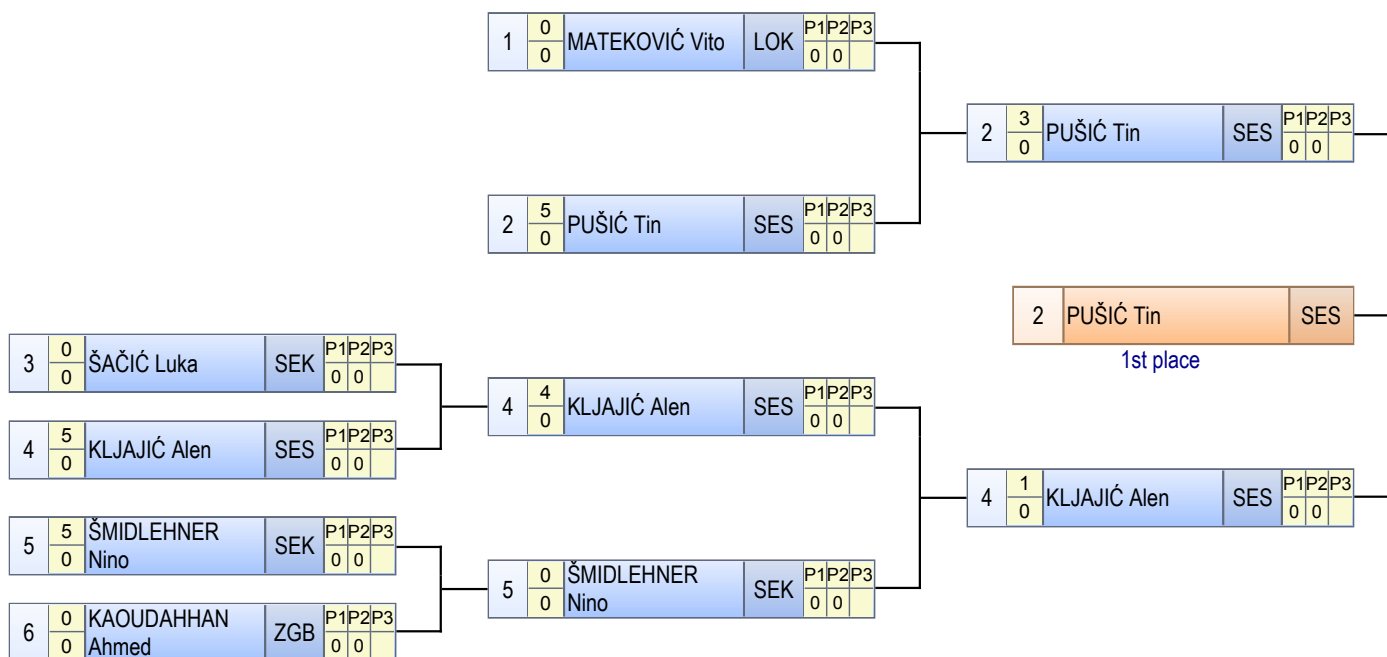

KONAČNI POREDAK

Plasman	Hrvač	Ekipa
1	PUŠIĆ Tin	SES
2	KLJAJIĆ Alen	SES
3	MATEKOVIĆ Vito	LOK
3	ŠMIDLEHNER Nino	SEKR
5	ŠAČIĆ Luka	SEKR
6	KAOUDAHAN Ahmed	ZGB

Repechage B

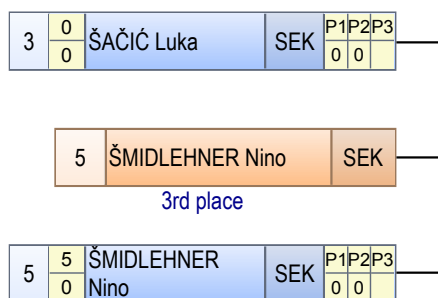



TABLICA ELIMINACIJE

Prvenstvo ZG žup za kadete i seniore GR

SEN GR 71 kg

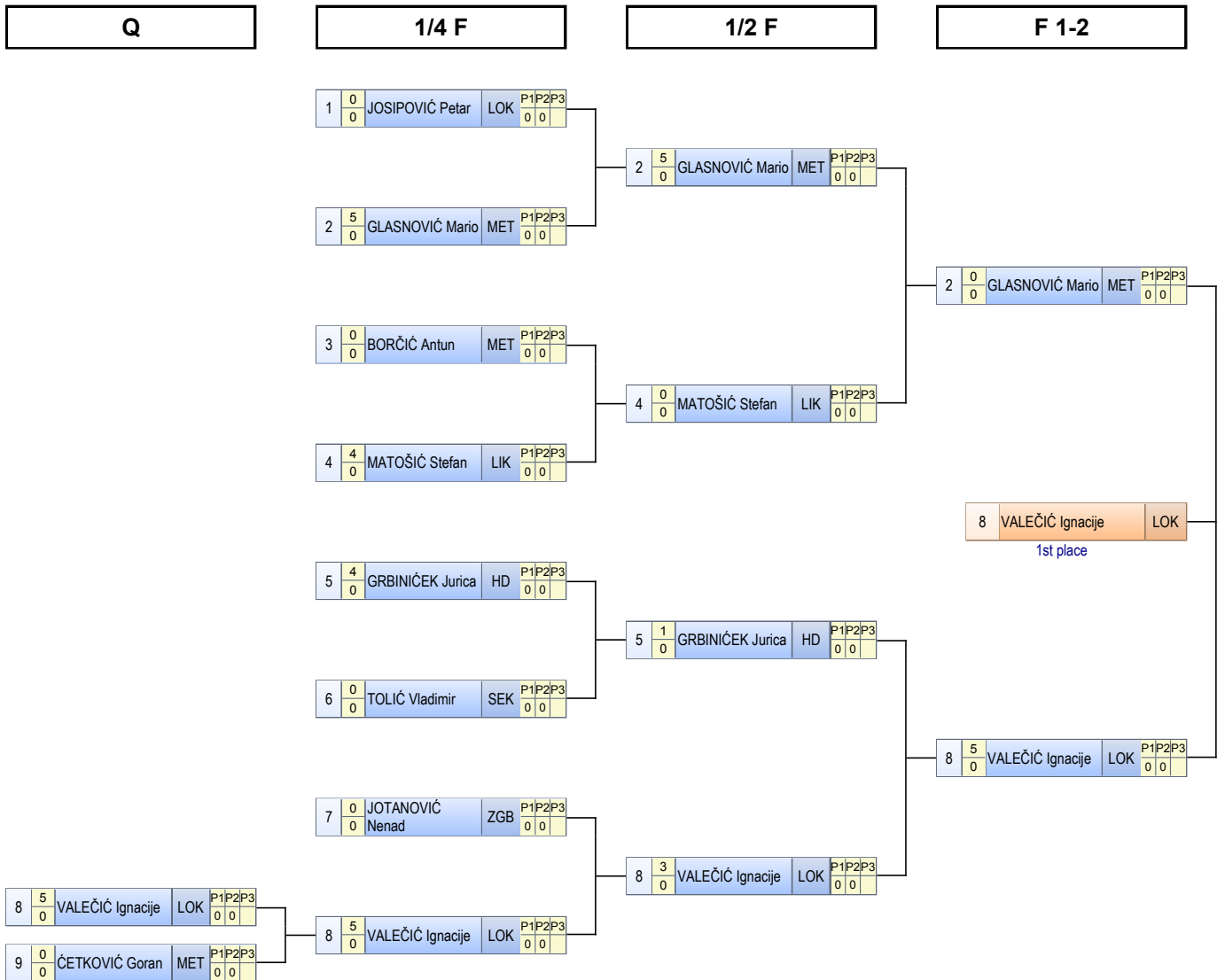

Repechage A



Repechage B

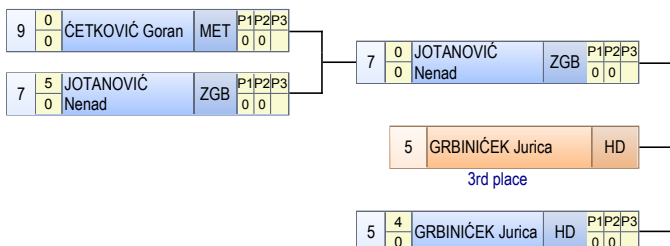

KONAČNI POREDAK

Plasman	Hrvač	Ekipa
1	VALEČIĆ Ignacije	LOK
2	GLASNOVIĆ Mario	MET
3	MATOŠIĆ Stefan	LIKA
3	GRBINIČEK Jurica	HD
5	JOSIPOVIĆ Petar	LOK
5	JOTANOVIĆ Nenad	ZGB
7	BORČIĆ Antun	MET
7	TOLIĆ Vladimir	SEKR
7	ČETKOVIĆ Goran	MET



TABLICA ELIMINACIJE

Prvenstvo ZG žup za kadete i seniore GR

SEN GR 75 kg

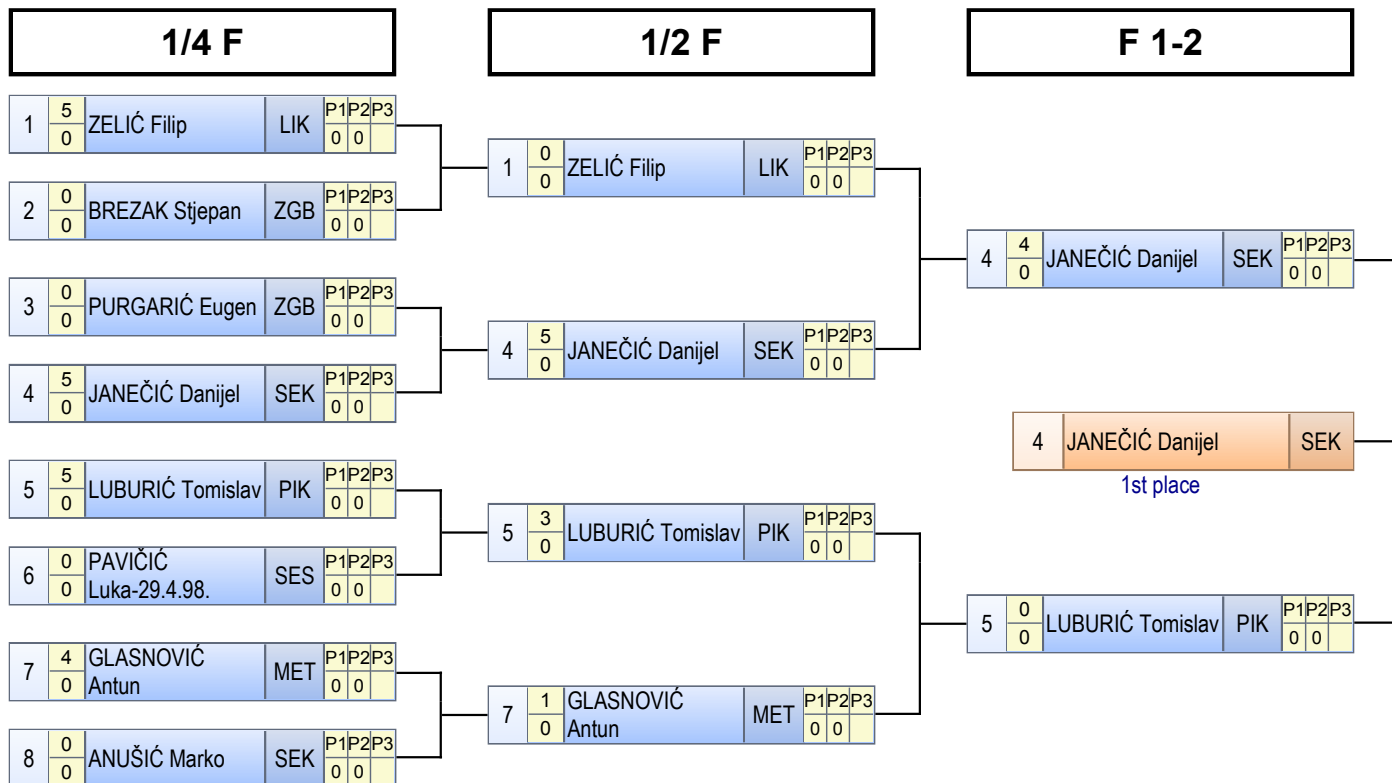

KONAČNI POREDAK

Repechage A

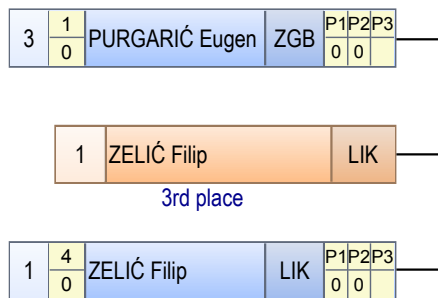

Repechage B



Plasman	Hrvač	Ekipa
1	JANEČIĆ Danijel	SEKR
2	LUBURIĆ Tomislav	PIKV
3	ZELIĆ Filip	LIKA
3	GLASNOVIĆ Antun	MET
5	PURGARIĆ Eugen	ZGB
5	PAVIČIĆ Luka-29.4.98.	SES
7	BREZAK Stjepan	ZGB
7	ANUŠIĆ Marko	SEKR



TABLICA ELIMINACIJE

Prvenstvo ZG žup za kadete i seniore GR

SEN GR 80 kg

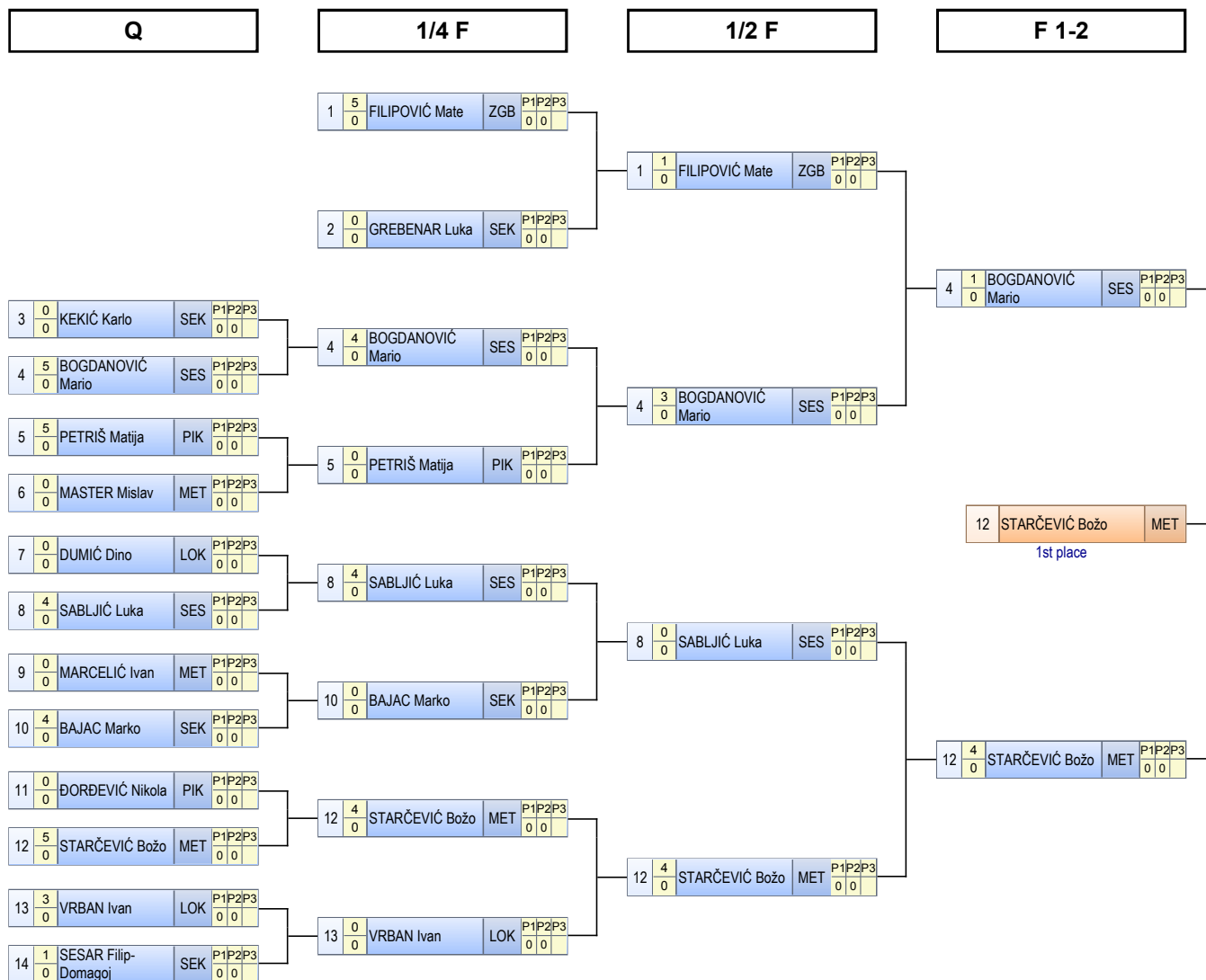

KONAČNI POREDAK

Plasman	Hrvač	Ekipa
1	STARČEVIĆ Božo	MET
2	BOGDANOVIĆ Mario	SES
3	FILIPOVIĆ Mate	ZGB
3	ĐORĐEVIĆ Nikola	PIKV
5	KEKIĆ Karlo	SEKR
5	SABLJIĆ Luka	SES
7	PETRIŠ Matija	PIKV
8	BAJAC Marko	SEKR
9	VRBAN Ivan	LOK
10	SESAR Filip-Domagoj	SEKR
11	GREBENAR Luka	SEKR
11	MASTER Mislav	MET
11	DUMIĆ Dino	LOK
11	MARCELIĆ Ivan	MET

Repechage A

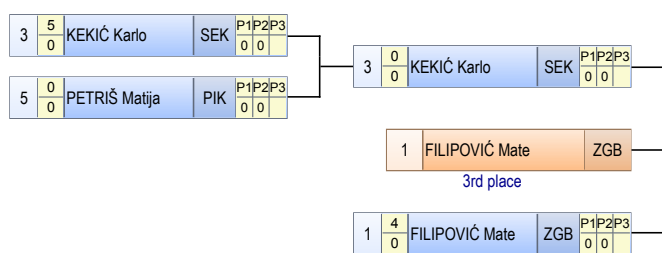

Repechage B

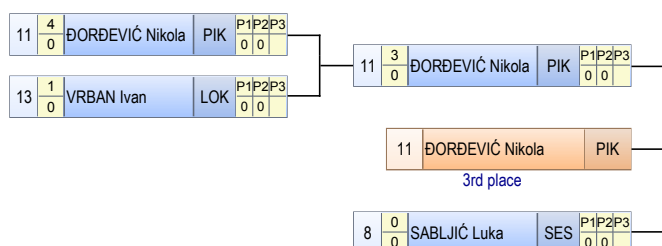



TABLICA ELIMINACIJE

Prvenstvo ZG žup za kadete i seniore GR

SEN GR 85 kg

Q

3	3 0	ŠAČIĆ Filip	SEK	P1P2P3 0 0
4	1 0	LUBURIĆ Vjekoslav	PIK	P1P2P3 0 0
5	0 0	MALIĆ Ivan Drago	SES	P1P2P3 0 0
6	5 0	ŽUGAJ Nenad	LIK	P1P2P3 0 0

1/2 F

1	0 0	GRETIĆ Marko	ZGB	P1P2P3 0 0
---	--------	--------------	-----	---------------

2	4 0	STJEPIĆ Mario	SEK	P1P2P3 0 0
---	--------	---------------	-----	---------------

3	0 0	ŠAČIĆ Filip	SEK	P1P2P3 0 0
---	--------	-------------	-----	---------------

6	4 0	ŽUGAJ Nenad	LIK	P1P2P3 0 0
---	--------	-------------	-----	---------------

F 1-2

2	0 0	STJEPIĆ Mario	SEK	P1P2P3 0 0
---	--------	---------------	-----	---------------

6		ŽUGAJ Nenad	LIK	
---	--	-------------	-----	--

1st place

6	4 0	ŽUGAJ Nenad	LIK	P1P2P3 0 0
---	--------	-------------	-----	---------------

Repechage B

5	0 0	MALIĆ Ivan Drago	SES	P1P2P3 0 0
---	--------	------------------	-----	---------------

3		ŠAČIĆ Filip	SEK	
---	--	-------------	-----	--

3rd place

3	5 0	ŠAČIĆ Filip	SEK	P1P2P3 0 0
---	--------	-------------	-----	---------------

KONAČNI POREDAK

Plasman	Hrvač	Ekipa
1	ŽUGAJ Nenad	LIKA
2	STJEPIĆ Mario	SEKR
3	GRETIĆ Marko	ZGB
3	ŠAČIĆ Filip	SEKR
5	MALIĆ Ivan Drago	SES
6	LUBURIĆ Vjekoslav	PIKV



TABLICA ELIMINACIJE

Prvenstvo ZG žup za kadete i seniore GR

SEN GR 98 kg

Q

2	0/0	BARIŠIĆ Bruno	ZGB	P1P2P3 0 0
3	4/0	KOPLJAR Stipo	SEK	P1P2P3 0 0
4	0/0	KONDRES Dario	SEK	P1P2P3 0 0
5	4/0	TOPOLOVEC Mihael	MET	P1P2P3 0 0
6	0/0	HUNDRIĆ Dominik	SEK	P1P2P3 0 0
7	4/0	TUPEK Matija	SES	P1P2P3 0 0

1/2 F

1	3/0	VIDOVIĆ Stjepan	SES	P1P2P3 0 0
3	1/0	KOPLJAR Stipo	SEK	P1P2P3 0 0
5	4/0	TOPOLOVEC Mihael	MET	P1P2P3 0 0
7	0/0	TUPEK Matija	SES	P1P2P3 0 0

F 1-2

1	1/0	VIDOVIĆ Stjepan	SES	P1P2P3 0 0
5	0/0	TOPOLOVEC Mihael	MET	
5	3/0	TOPOLOVEC Mihael	MET	P1P2P3 0 0

1st place

Repechage A

3	0/0	KOPLJAR Stipo	SEK	P1P2P3 0 0
3	0/0	KOPLJAR Stipo	SEK	
3	0/0			P1P2P3 0 0

3rd place

Repechage B

4	1/0	KONDRES Dario	SEK	P1P2P3 0 0
7	0/0	TUPEK Matija	SES	
7	4/0	TUPEK Matija	SES	P1P2P3 0 0

3rd place

KONAČNI POREDAK

Plasman	Hrvač	Ekipa
1	TOPOLOVEC Mihael	MET
2	VIDOVIĆ Stjepan	SES
3	KOPLJAR Stipo	SEKR
3	TUPEK Matija	SES
5	KONDRES Dario	SEKR
6	BARIŠIĆ Bruno	ZGB
6	HUNDRIĆ Dominik	SEKR



TABLICA ELIMINACIJE

Prvenstvo ZG žup za kadete i seniore GR

SEN GR 130 kg

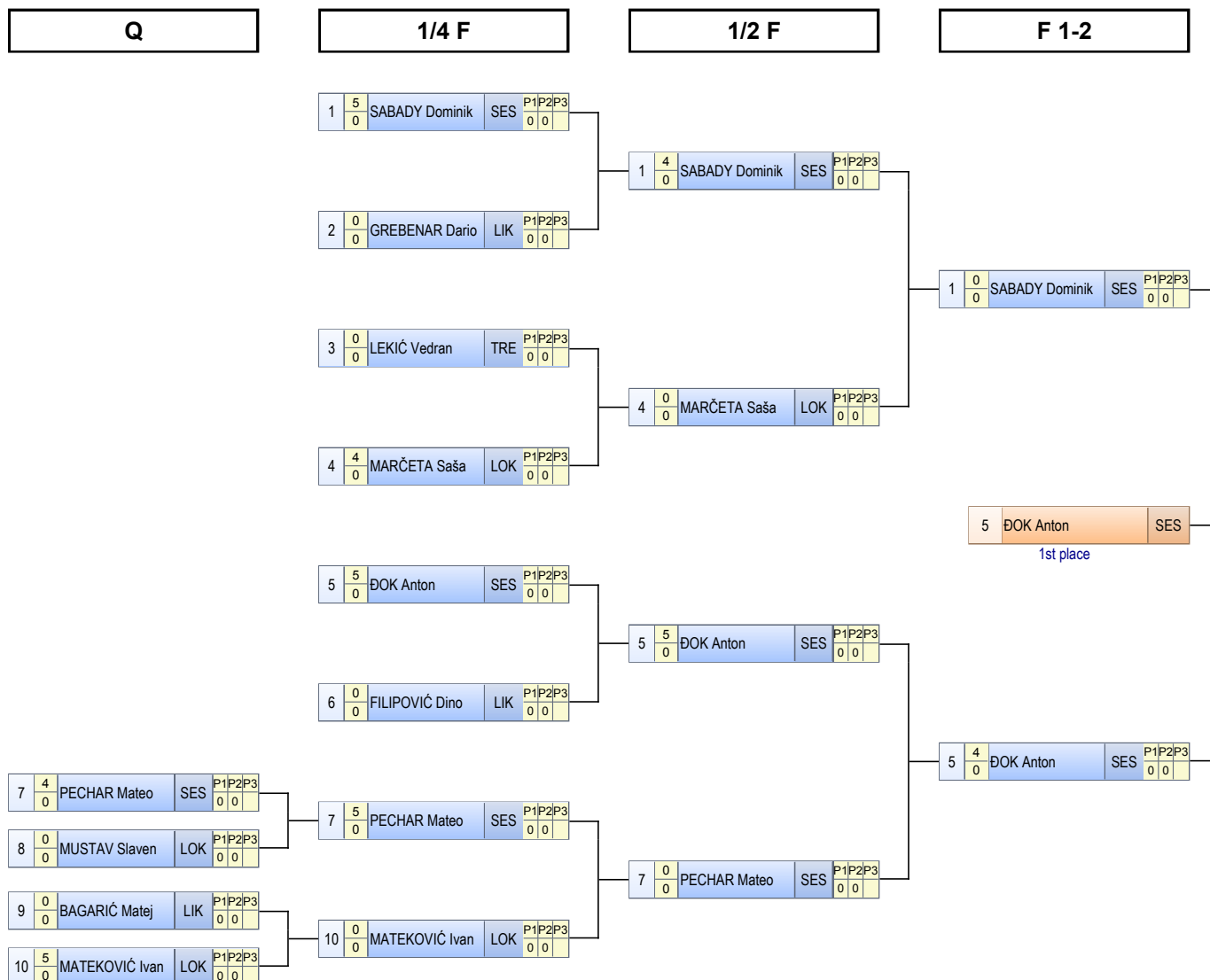

Repechage A

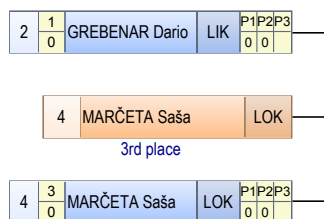

Repechage B

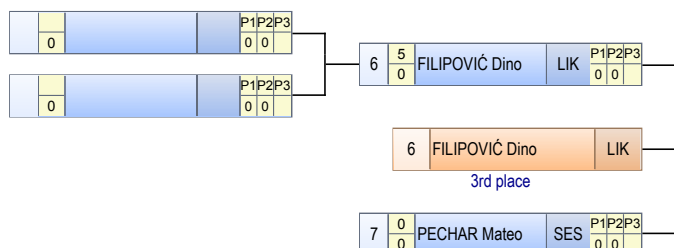

KONAČNI POREDAK

Plasman	Hrvač	Ekipa
1	ĐOK Anton	SES
2	SABADY Dominik	SES
3	MARČETA Saša	LOK
3	FILIPOVIĆ Dino	LIKA
5	GREBENAR Dario	LIKA
5	PECHAR Mateo	SES
7	MATEKOVIĆ Ivan	LOK
8	LEKIĆ Vedran	TREŠ
8	MUSTAV Slaven	LOK
8	BAGARIĆ Matej	LIKA



POJEDINAČNI POREDAK PO KATEGORIJAMA

Prvenstvo ZG žup za kadete i seniore GR

SEN GR

59 kg			
1	BRALA Tony	ZAGREB	7.0
2	PETRAK Mario	LOKOMOTIVA	5.0
3	BOLFEK Ivica	PIK VRBOVEC	3.5
4	ČIČAK Patric	SESVETSKI KRALJEVEC	3.5
			19.0
66 kg			
1	PUŠIĆ Tin	SESVETE	7.0
2	KLJAJIĆ Alen	SESVETE	5.0
3	MATEKOVIĆ Vito	LOKOMOTIVA	3.5
3	ŠMIDLEHNER Nino	SESVETSKI KRALJEVEC	3.5
			19.0
71 kg			
1	VALEČIĆ Ignacije	LOKOMOTIVA	7.0
2	GLASNOVIĆ Mario	METALAC	5.0
3	MATOŠIĆ Stefan	LIKA	3.5
3	GRBINIČEK Jurica	HRVATSKI DRAGOVOLJAC	3.5
			19.0
75 kg			
1	JANEČIĆ Danijel	SESVETSKI KRALJEVEC	7.0
2	LUBURIĆ Tomislav	PIK VRBOVEC	5.0
3	ZELIĆ Filip	LIKA	3.5
3	GLASNOVIĆ Antun	METALAC	3.5
			19.0
80 kg			
1	STARČEVIĆ Božo	METALAC	7.0
2	BOGDANOVIĆ Mario	SESVETE	5.0
3	FILIPOVIĆ Mate	ZAGREB	3.5
3	ĐORĐEVIĆ Nikola	PIK VRBOVEC	3.5
			19.0
85 kg			
1	ŽUGAJ Nenad	LIKA	7.0
2	STJEPIĆ Mario	SESVETSKI KRALJEVEC	5.0
3	GRETIĆ Marko	ZAGREB	3.5
3	ŠAČIĆ Filip	SESVETSKI KRALJEVEC	3.5
			19.0
98 kg			
1	TOPOLOVEC Mihael	METALAC	7.0
2	VIDOVIĆ Stjepan	SESVETE	5.0
3	KOPLJAR Stipo	SESVETSKI KRALJEVEC	3.5
3	TUPEK Matija	SESVETE	3.5
			19.0
130 kg			
1	ĐOK Anton	SESVETE	7.0
2	SABADY Dominik	SESVETE	5.0
3	MARČETA Saša	LOKOMOTIVA	3.5
3	FILIPOVIĆ Dino	LIKA	3.5
			19.0



EKIPNI PLASMAN

Prvenstvo ZG žup za kadete i seniore GR

SEN GR

R.br.	EKIPA	MJESTO	59 kg	66 kg	71 kg	75 kg	80 kg	85 kg	98 kg	130 kg	Ukupno
1	SESVETE	ZAGREB		12.0			5.0		8.5	12.0	37.5
2	SESVETSKI KRALJEVEC	SESV. KRALJEVEC	3.5	3.5		7.0		8.5	3.5		26.0
3	METALAC	ZAGREB			5.0	3.5	7.0		7.0		22.5
4	LOKOMOTIVA	ZAGREB	5.0	3.5	7.0					3.5	19.0
5	LIKA	ZAGREB			3.5	3.5		7.0		3.5	17.5
6	ZAGREB	ZAGREB	7.0				3.5	3.5			14.0
7	PIK VRBOVEC	VRBOVEC	3.5			5.0	3.5				12.0
8	HRVATSKI DRAGOVOLJAC	ZAGREB			3.5						3.5
9	TREŠNJEVKA	ZAGREB									0.0
UKUPNO			19	19	19	19	19	19	19	19	152